

## Product Summary

| $BV_{DSS}$ | $R_{DS(ON) MAX}$                | $I_D$<br>$T_A = +25^\circ C$ |
|------------|---------------------------------|------------------------------|
| -30V       | 45m $\Omega$ @ $V_{GS} = -10V$  | -4.3A                        |
|            | 65m $\Omega$ @ $V_{GS} = -4.5V$ | -3.3A                        |

## Description

This new generation MOSFET has been designed to minimize the on-state resistance ( $R_{DS(ON)}$ ) and yet maintain superior switching performance, making it ideal for high efficiency power management applications.

## Applications

- General Purpose Interfacing Switch
- Power Management Functions
- Analog Switch

## Features

- Low Gate Threshold Voltage
- Low On-Resistance
- **Totally Lead-Free & Fully RoHS Compliant (Notes 1 & 2)**
- **Halogen and Antimony Free. "Green" Device (Note 3)**
- **Qualified to AEC-Q101 Standards for High Reliability**
- **PPAP Capable (Note 4)**

## Mechanical Data

- Case: SOT26
- Case Material – Molded Plastic, "Green" Molding Compound. UL Flammability Rating 94V-0
- Moisture Sensitivity: Level 1 per J-STD-020
- Terminals: Finish - Matte Tin Annealed over Copper Leadframe. Solderable per MIL-STD-202, Method 208  $\text{\textcircled{3}}$
- Terminal Connections: See Diagram
- Weight: 0.016 grams (Approximate)

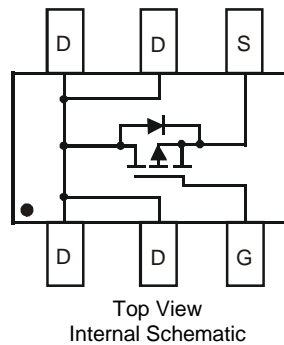

## Ordering Information (Note 5)

| Part Number   | Qualification | Case  | Packaging        |
|---------------|---------------|-------|------------------|
| DMP3056LDM-7  | Commercial    | SOT26 | 3000/Tape & Reel |
| DMP3056LDMQ-7 | Automotive    | SOT26 | 3000/Tape & Reel |

- Notes:
1. No purposely added lead. Fully EU Directive 2002/95/EC (RoHS) & 2011/65/EU (RoHS 2) compliant.
  2. See [http://www.diodes.com/quality/lead\\_free.html](http://www.diodes.com/quality/lead_free.html) for more information about Diodes Incorporated's definitions of Halogen- and Antimony-free, "Green" and Lead-free.
  3. Halogen- and Antimony-free "Green" products are defined as those which contain <900ppm bromine, <900ppm chlorine (<1500ppm total Br + Cl) and <1000ppm antimony compounds.
  4. Automotive products are AEC-Q101 qualified and are PPAP capable. Automotive, AEC-Q101 and standard products are electrically and thermally the same, except where specified. For more information, please refer to [http://www.diodes.com/product\\_compliance\\_definitions.html](http://www.diodes.com/product_compliance_definitions.html).
  5. For packaging details, go to our website at <http://www.diodes.com/products/packages.html>.

## Marking Information

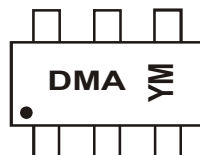

DMA = Product Type Marking Code  
 YM = Date Code Marking  
 Y = Year (ex: V = 2008)  
 M = Month (ex: 9 = September)

### Date Code Key

| Year | 2008 | ~ | 2016 | 2017 | 2018 | 2019 | 2020 | 2021 |
|------|------|---|------|------|------|------|------|------|
| Code | V    | ~ | D    | E    | F    | G    | H    | I    |

| Month | Jan | Feb | Mar | Apr | May | Jun | Jul | Aug | Sep | Oct | Nov | Dec |
|-------|-----|-----|-----|-----|-----|-----|-----|-----|-----|-----|-----|-----|
| Code  | 1   | 2   | 3   | 4   | 5   | 6   | 7   | 8   | 9   | O   | N   | D   |

**Maximum Ratings** (@T<sub>A</sub> = +25°C, unless otherwise specified.)

| Characteristic   | Symbol           | Value                  | Unit                  |
|--|------------------|------------------------|-----------------------|
| Drain-Source Voltage                                     | V <sub>DSS</sub> | -30                    | V                     |
| Gate-Source Voltage                                      | V <sub>GSS</sub> | ±20                    | V                     |
| Continuous Drain Current (Note 7) V <sub>GS</sub> = -10V | Steady State     | T <sub>A</sub> = +25°C | I <sub>D</sub> -4.3 A |
|  | t < 10s          | T <sub>A</sub> = +25°C | I <sub>D</sub> -5.8 A |
| Maximum Continuous Body Diode Forward Current (Note 7)   | I <sub>S</sub>   | -2.3                   | A                     |
| Pulsed Drain Current (10μs Pulse, Duty Cycle = 1%)       | I <sub>DM</sub>  | -13                    | A                     |

**Thermal Characteristics**

| Characteristic                                   | Symbol                            | Value       | Unit |
|--|-----------------------------------|-------------|------|
| Total Power Dissipation (Note 6)                 | P <sub>D</sub>                    | 1.25        | W    |
| Thermal Resistance, Junction to Ambient (Note 6) | R <sub>θJA</sub>                  | 100         | °C/W |
| Total Power Dissipation (Note 7)                 | P <sub>D</sub>                    | 1.5         | W    |
| Thermal Resistance, Junction to Ambient (Note 7) | R <sub>θJA</sub>                  | 86          | °C/W |
| Thermal Resistance, Junction to Case             | R <sub>θJC</sub>                  | 15.6        | °C/W |
| Operating and Storage Temperature Range          | T <sub>J</sub> , T <sub>STG</sub> | -55 to +150 | °C   |

**Electrical Characteristics** (@T<sub>A</sub> = +25°C, unless otherwise specified.)

| Characteristic                            | Symbol              | Min  | Typ   | Max          | Unit | Test Condition  |
|---|---------------------|------|-------|--------------|------|---|
| <b>STATIC PARAMETERS (Note 8)</b>         |                     |      |       |              |      |   |
| Drain-Source Breakdown Voltage            | BV <sub>DSS</sub>   | -30  | —     | —            | V    | V <sub>GS</sub> = 0V, I <sub>D</sub> = -250μA   |
| Zero Gate Voltage Drain Current           | I <sub>DSS</sub>    | —    | —     | -1           | μA   | T <sub>J</sub> = +25°C, V <sub>GS</sub> = 0V, V <sub>DS</sub> = -30V                            |
| Gate-Body Leakage Current                 | I <sub>GSS</sub>    | —    | —     | ±100<br>±800 | nA   | V <sub>GS</sub> = ±20V, V <sub>DS</sub> = 0V<br>V <sub>GS</sub> = ±25V, V <sub>DS</sub> = 0V    |
| Gate Threshold Voltage                    | V <sub>GS(TH)</sub> | -1.0 | —     | -2.1         | V    | V <sub>GS</sub> = V <sub>DS</sub> , I <sub>D</sub> = -250μA                                     |
| Static Drain-Source On-Resistance         | R <sub>DS(ON)</sub> | —    | —     | 45<br>65     | mΩ   | V <sub>GS</sub> = -10V, I <sub>D</sub> = -5A<br>V <sub>GS</sub> = -4.5V, I <sub>D</sub> = -4.2A |
| Forward Transconductance                  | g <sub>FS</sub>     | —    | 8     | —            | s    | V <sub>DS</sub> = -10V, I <sub>D</sub> = -4.3A  |
| Diode Forward Voltage                     | V <sub>SD</sub>     | —    | —     | -1.2         | V    | V <sub>GS</sub> = 0V, I <sub>S</sub> = -1.7A  |
| <b>DYNAMIC PARAMETERS (Note 9)</b>        |                     |      |       |              |      |   |
| Input Capacitance                         | C <sub>iss</sub>    | —    | 948   | —            | pF   | V <sub>GS</sub> = 0V, V <sub>DS</sub> = -25V,<br>f = 1.0MHz                                     |
| Output Capacitance                        | C <sub>oss</sub>    | —    | 105   | —            | pF   |   |
| Reverse Transfer Capacitance              | C <sub>rss</sub>    | —    | 100   | —            | pF   |   |
| <b>SWITCHING CHARACTERISTICS (Note 9)</b> |                     |      |       |              |      |   |
| Total Gate Charge                         | Q <sub>g</sub>      | —    | 10.1  | —            | nC   | V <sub>DS</sub> = -15V, V <sub>GS</sub> = -4.5V,<br>I <sub>D</sub> = -6A                        |
|   | Q <sub>g</sub>      | —    | 21.1  | —            | nC   |   |
| Gate-Source Charge                        | Q <sub>gs</sub>     | —    | 2.8   | —            | nC   | V <sub>DS</sub> = -15V, V <sub>GS</sub> = -10V,<br>I <sub>D</sub> = -6A                         |
| Gate-Drain Charge                         | Q <sub>gd</sub>     | —    | 3.2   | —            | nC   |   |
| Gate Resistance                           | R <sub>g</sub>      | —    | 13.15 | —            | Ω    | V <sub>DS</sub> = 0V, V <sub>GS</sub> = 0V, f = 1MHz  |
| Turn-On Delay Time                        | t <sub>D(ON)</sub>  | —    | 10.2  | —            | ns   | V <sub>DS</sub> = -15V, V <sub>GS</sub> = -10V,<br>I <sub>D</sub> = -1A, R <sub>g</sub> = 6.0Ω  |
| Rise Time                                 | t <sub>R</sub>      | —    | 6.6   | —            |      |   |
| Turn-Off Delay Time                       | t <sub>D(OFF)</sub> | —    | 50.1  | —            |      |   |
| Fall Time                                 | t <sub>F</sub>      | —    | 22.3  | —            |      |   |

- Notes:
- Device mounted on FR-4 substrate PC board, 2oz copper, with minimum recommended pad layout.
  - Device mounted on FR-4 substrate PC board, 2oz copper, with 1inch square copper pad.
  - Short duration pulse test used to minimize self-heating effect.
  - Guaranteed by design. Not subject to product testing.

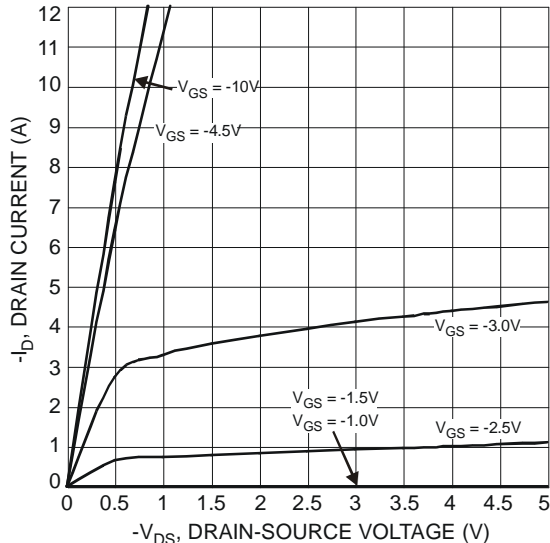

Fig. 1 Typical Output Characteristics

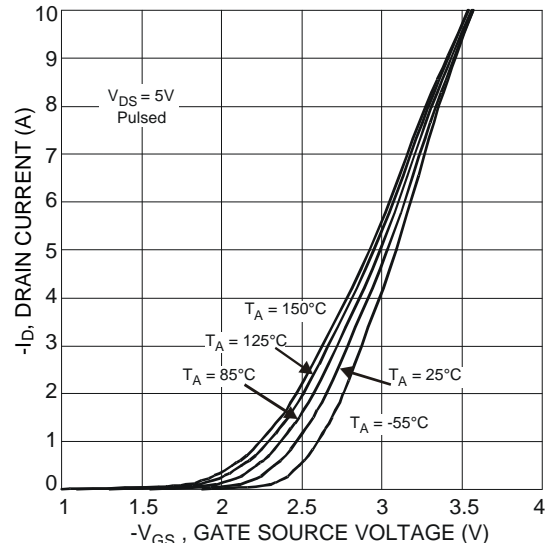

Fig. 2 Typical Transfer Characteristics

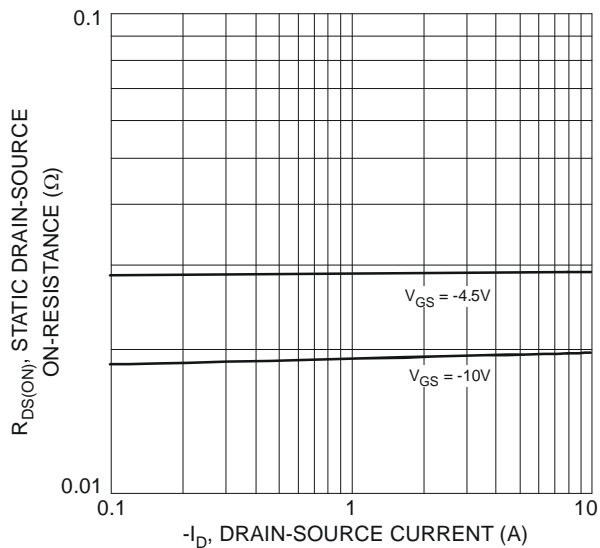

Fig. 3 On-Resistance vs. Drain Current & Gate Voltage

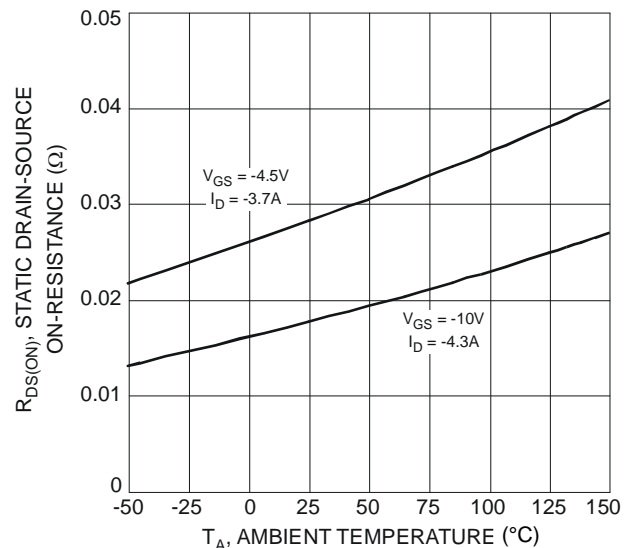

Fig. 4 Static Drain-Source On-Resistance vs. Ambient Temperature

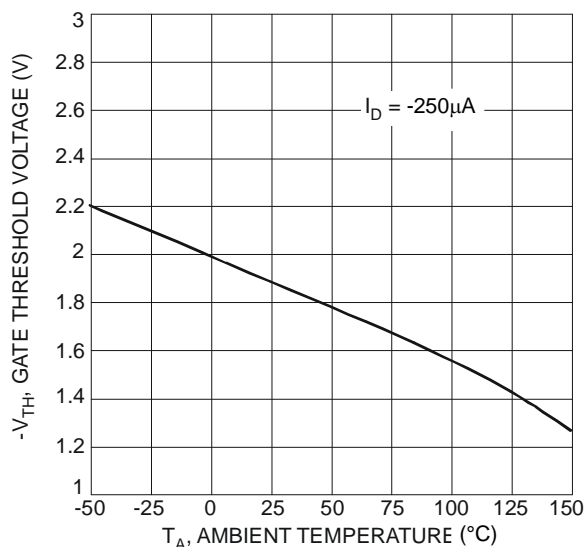

Fig. 5 Gate Threshold Variation vs. Ambient Temperature

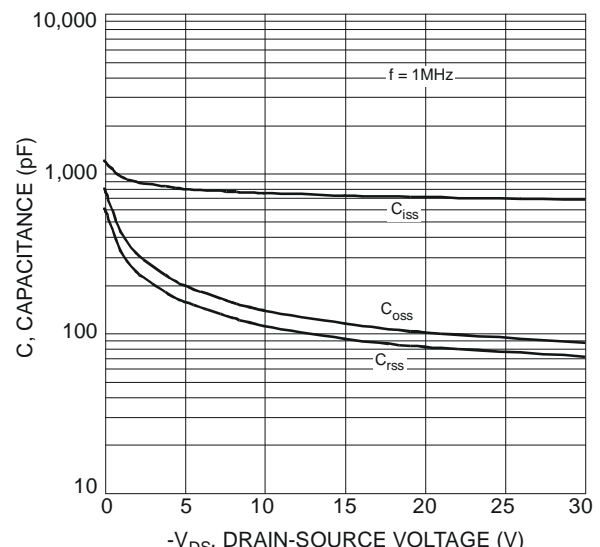

Fig. 6 Typical Total Capacitance

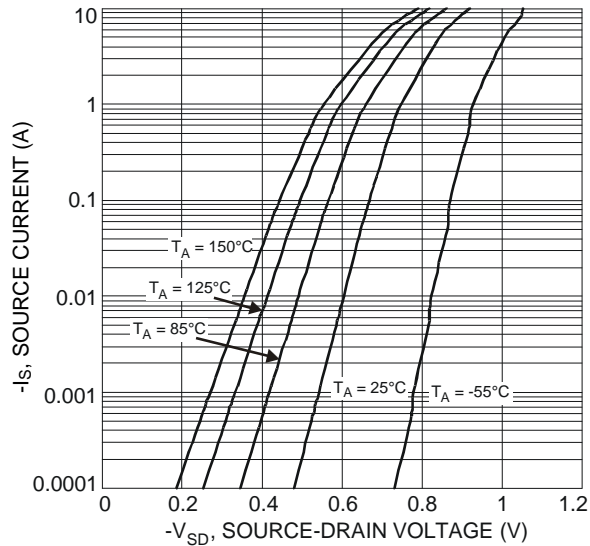

Fig. 7 Reverse Drain Current vs. Source-Drain Voltage

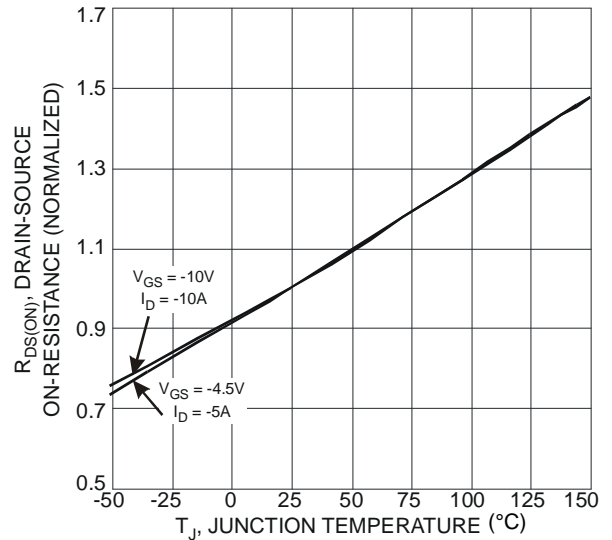

Fig. 8 On-Resistance Variation with Temperature

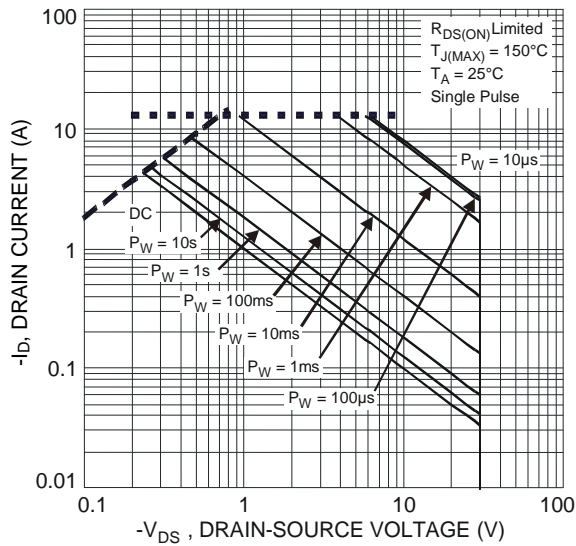

Fig. 9 Safe Operation Area

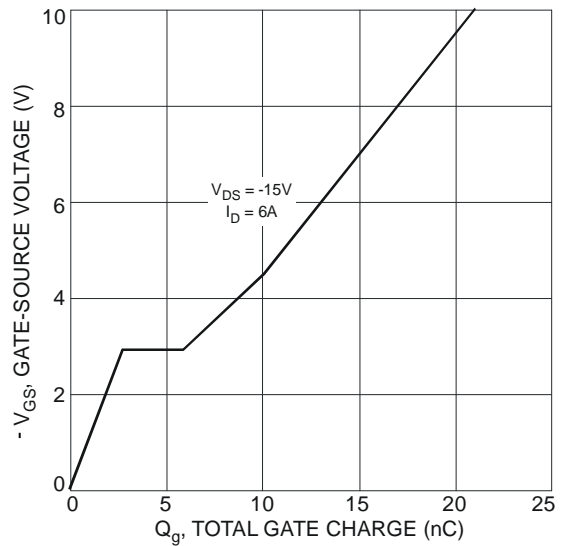

Fig. 10 Gate-Charge Characteristics

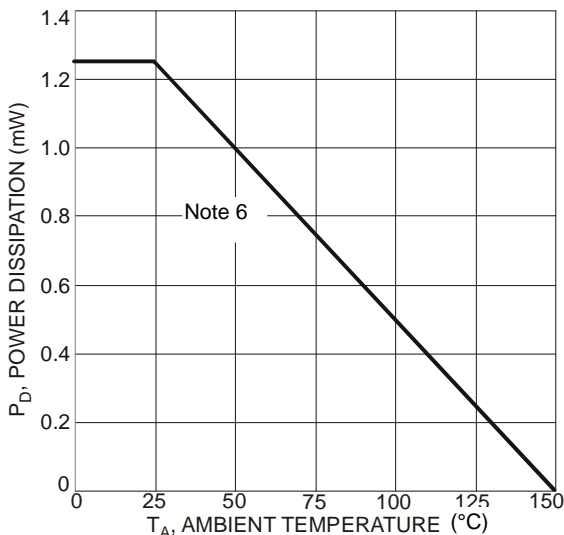

Fig. 11 Power Dissipation vs. Ambient Temperature

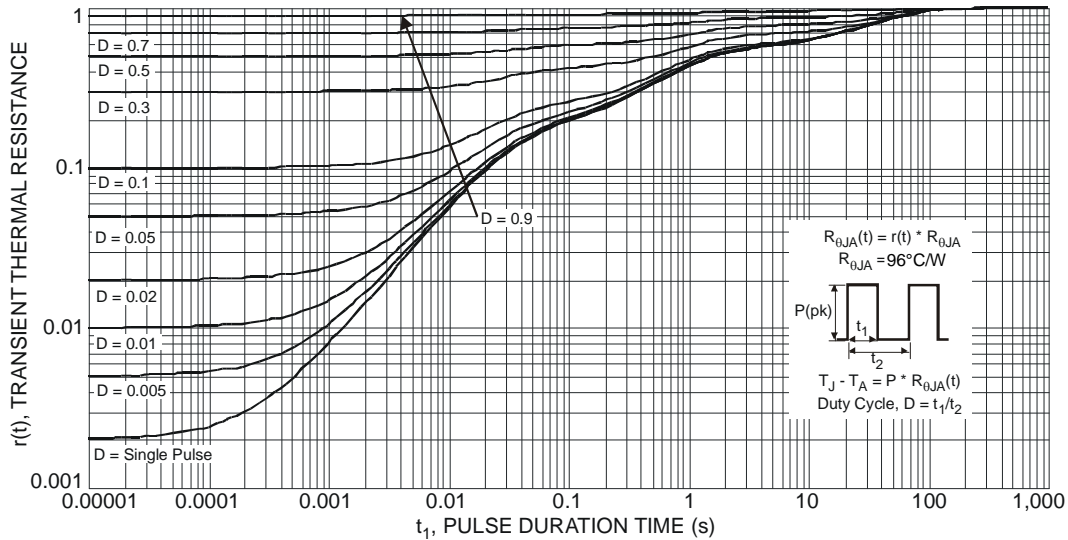
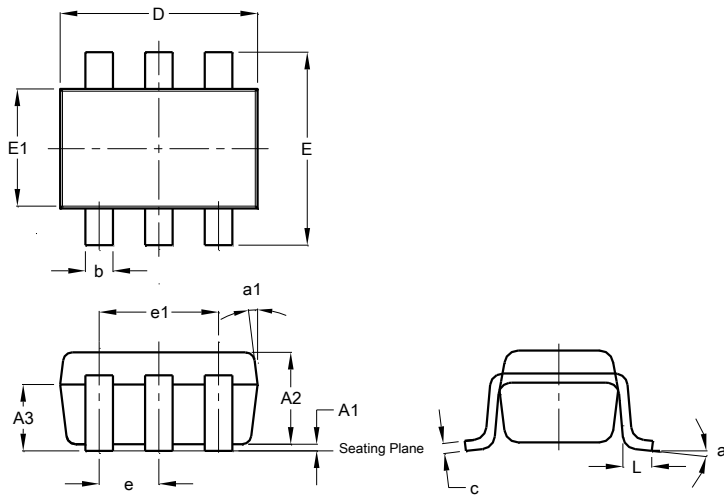

Fig. 12 Transient Thermal Response

**Package Outline Dimensions**

Please see <http://www.diodes.com/package-outlines.html> for the latest version.

**SOT26**



| SOT26                |       |      |      |
|----------------------|-------|------|------|
| Dim                  | Min   | Max  | Typ  |
| A1                   | 0.013 | 0.10 | 0.05 |
| A2                   | 1.00  | 1.30 | 1.10 |
| A3                   | 0.70  | 0.80 | 0.75 |
| b                    | 0.35  | 0.50 | 0.38 |
| c                    | 0.10  | 0.20 | 0.15 |
| D                    | 2.90  | 3.10 | 3.00 |
| e                    | -     | -    | 0.95 |
| e1                   | -     | -    | 1.90 |
| E                    | 2.70  | 3.00 | 2.80 |
| E1                   | 1.50  | 1.70 | 1.60 |
| L                    | 0.35  | 0.55 | 0.40 |
| a                    | -     | -    | 8°   |
| a1                   | -     | -    | 7°   |
| All Dimensions in mm |       |      |      |

**Suggested Pad Layout**

Please see <http://www.diodes.com/package-outlines.html> for the latest version.

**SOT26**

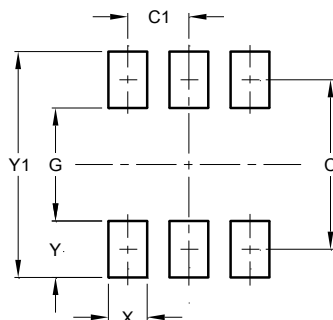

| Dimensions | Value (in mm) |
|------------|---------------|
| C          | 2.40          |
| C1         | 0.95          |
| G          | 1.60          |
| X          | 0.55          |
| Y          | 0.80          |
| Y1         | 3.20          |

**IMPORTANT NOTICE**

DIODES INCORPORATED MAKES NO WARRANTY OF ANY KIND, EXPRESS OR IMPLIED, WITH REGARDS TO THIS DOCUMENT, INCLUDING, BUT NOT LIMITED TO, THE IMPLIED WARRANTIES OF MERCHANTABILITY AND FITNESS FOR A PARTICULAR PURPOSE (AND THEIR EQUIVALENTS UNDER THE LAWS OF ANY JURISDICTION).

Diodes Incorporated and its subsidiaries reserve the right to make modifications, enhancements, improvements, corrections or other changes without further notice to this document and any product described herein. Diodes Incorporated does not assume any liability arising out of the application or use of this document or any product described herein; neither does Diodes Incorporated convey any license under its patent or trademark rights, nor the rights of others. Any Customer or user of this document or products described herein in such applications shall assume all risks of such use and will agree to hold Diodes Incorporated and all the companies whose products are represented on Diodes Incorporated website, harmless against all damages.

Diodes Incorporated does not warrant or accept any liability whatsoever in respect of any products purchased through unauthorized sales channel. Should Customers purchase or use Diodes Incorporated products for any unintended or unauthorized application, Customers shall indemnify and hold Diodes Incorporated and its representatives harmless against all claims, damages, expenses, and attorney fees arising out of, directly or indirectly, any claim of personal injury or death associated with such unintended or unauthorized application.

Products described herein may be covered by one or more United States, international or foreign patents pending. Product names and markings noted herein may also be covered by one or more United States, international or foreign trademarks.

This document is written in English but may be translated into multiple languages for reference. Only the English version of this document is the final and determinative format released by Diodes Incorporated.

**LIFE SUPPORT**

Diodes Incorporated products are specifically not authorized for use as critical components in life support devices or systems without the express written approval of the Chief Executive Officer of Diodes Incorporated. As used herein:

A. Life support devices or systems are devices or systems which:

1. are intended to implant into the body, or
2. support or sustain life and whose failure to perform when properly used in accordance with instructions for use provided in the labeling can be reasonably expected to result in significant injury to the user.

B. A critical component is any component in a life support device or system whose failure to perform can be reasonably expected to cause the failure of the life support device or to affect its safety or effectiveness.

Customers represent that they have all necessary expertise in the safety and regulatory ramifications of their life support devices or systems, and acknowledge and agree that they are solely responsible for all legal, regulatory and safety-related requirements concerning their products and any use of Diodes Incorporated products in such safety-critical, life support devices or systems, notwithstanding any devices- or systems-related information or support that may be provided by Diodes Incorporated. Further, Customers must fully indemnify Diodes Incorporated and its representatives against any damages arising out of the use of Diodes Incorporated products in such safety-critical, life support devices or systems.

Copyright © 2016, Diodes Incorporated

[www.diodes.com](http://www.diodes.com)